

5G COMBO MIMO MOBILE ROOF SMA ANTENNA



Mechanical/Environmental

Cable	4x ALS302, 3000 mm
Operating temperature	-40 °C to +85 °C
Mounting method	Screw (M27 nut)
IP rating	IP67 (after installation) / IP69K (after installation)
Weight	701 g
RoHS compliant	✓

5G mobile MIMO antenna

Frequency range	600 ~ 960, 1400 ~ 6000 MHz
Polarization	Linear
Radiation pattern type	Omni-directional
Gain	Max 4.7 dBi
V.S.W.R	≤ 3.4
Impedance	50 Ω
Connector type and count	4x SMA Male

Radiation patterns

Mobile - 1 Antenna

ELEVATION

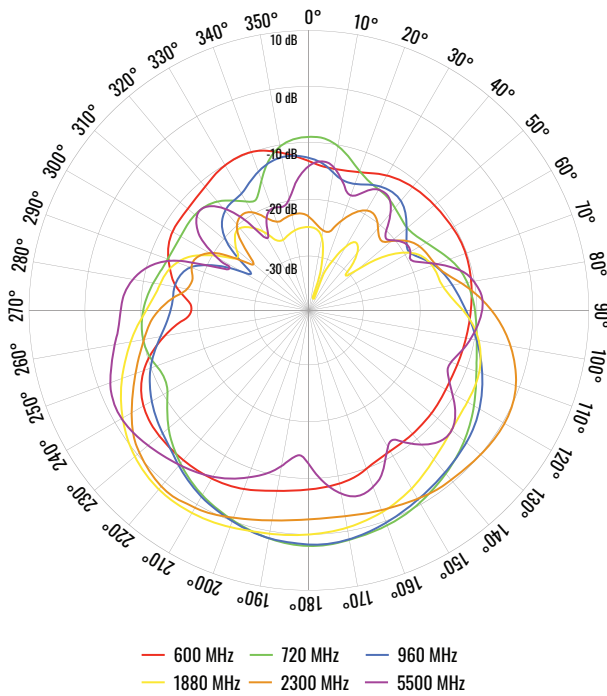

AZIMUTH

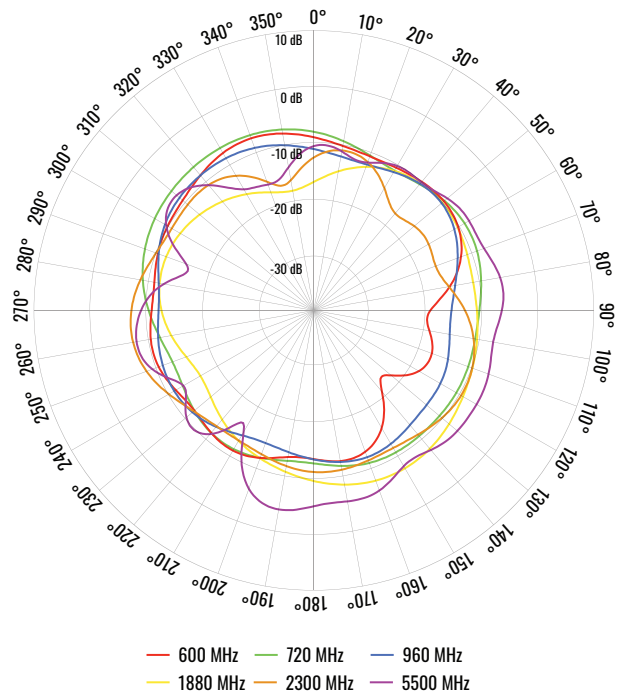

Mobile - 2 Antenna

ELEVATION

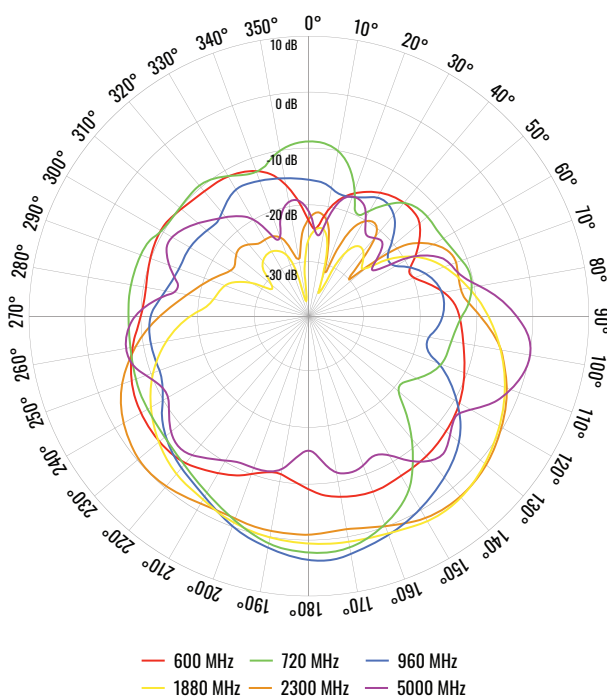

AZIMUTH

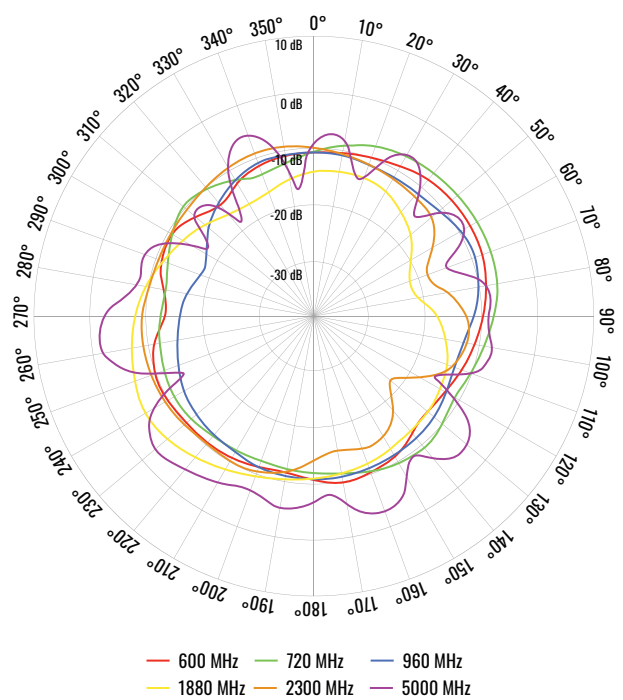

Radiation patterns

Mobile- 3 Antenna

ELEVATION

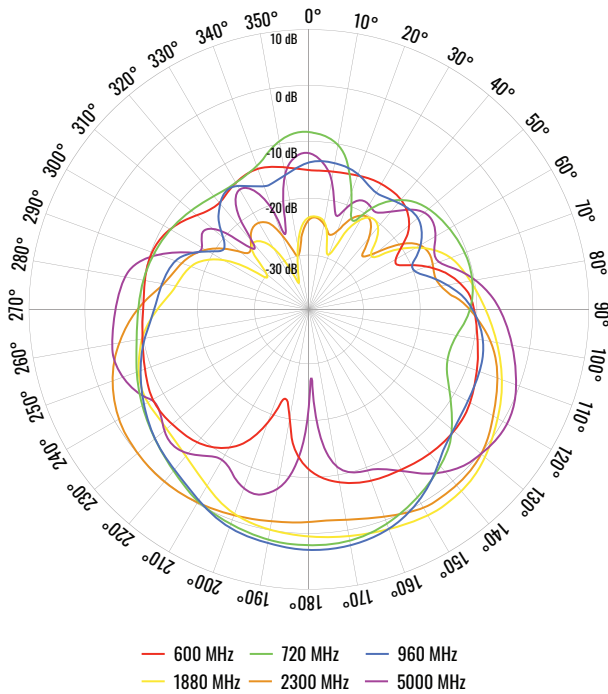

AZIMUTH

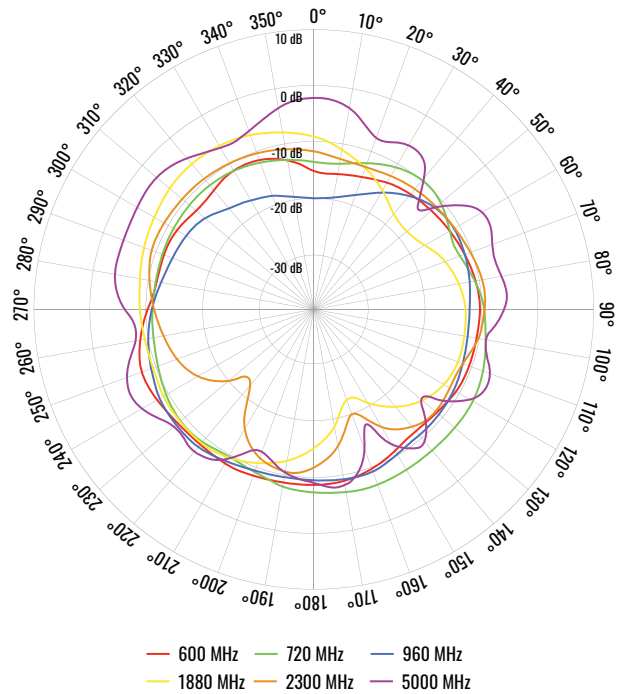

Mobile - 4 Antenna

ELEVATION

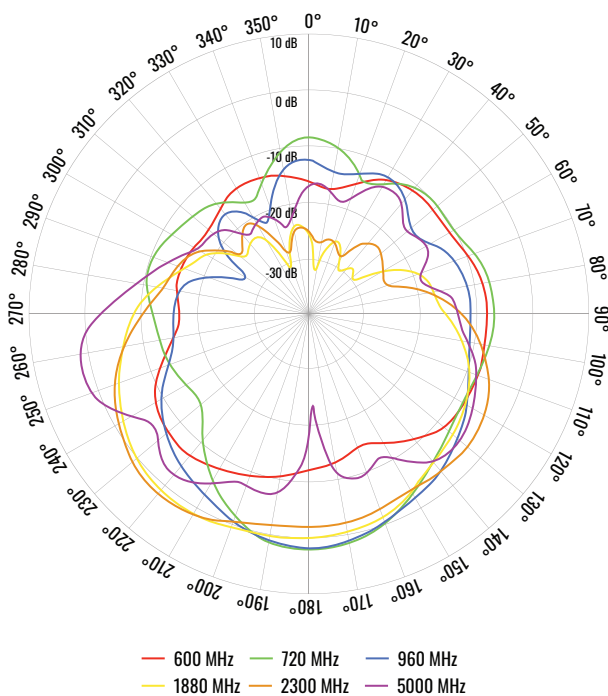

AZIMUTH

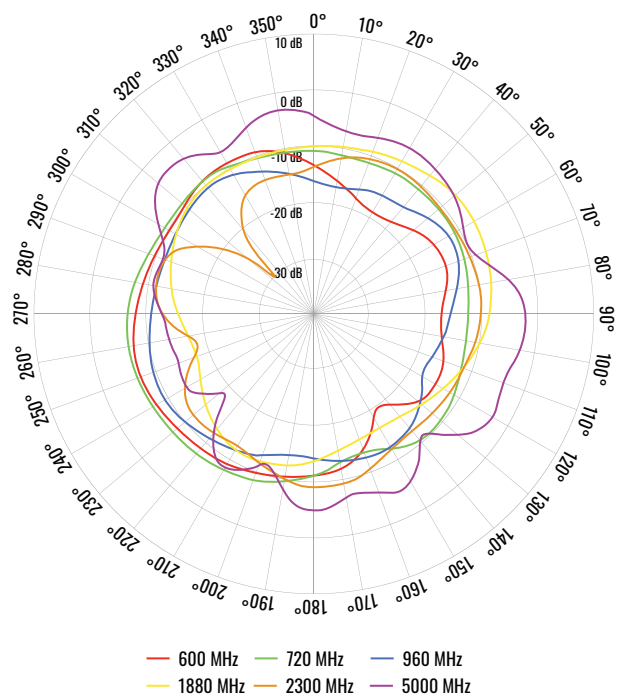

Spatial measurements

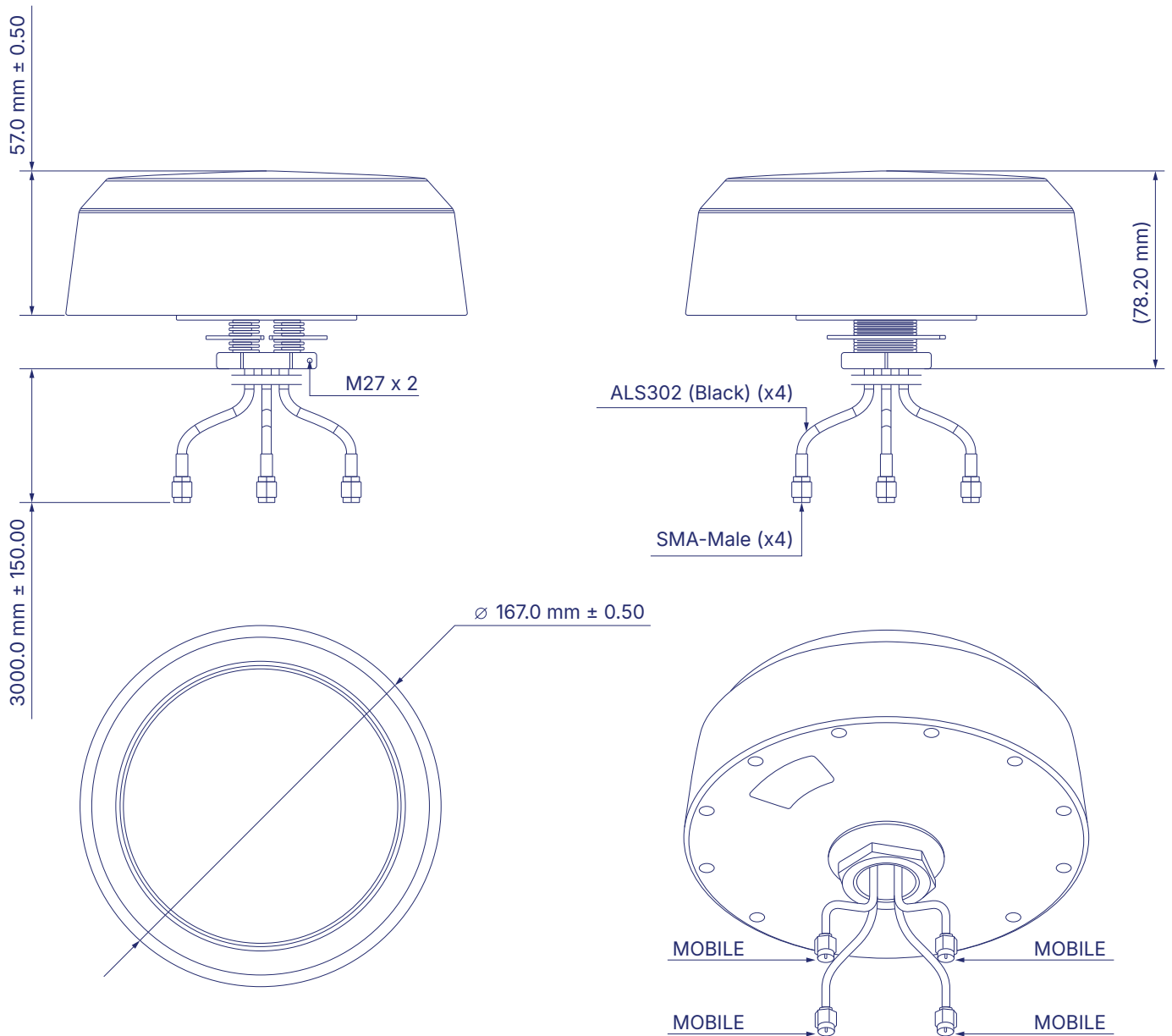

Notes:

1. Units: mm.
2. Recommended assembly hole diameter: 28.00 mm.
3. Recommended mounting plane thickness: 3.00 mm.